

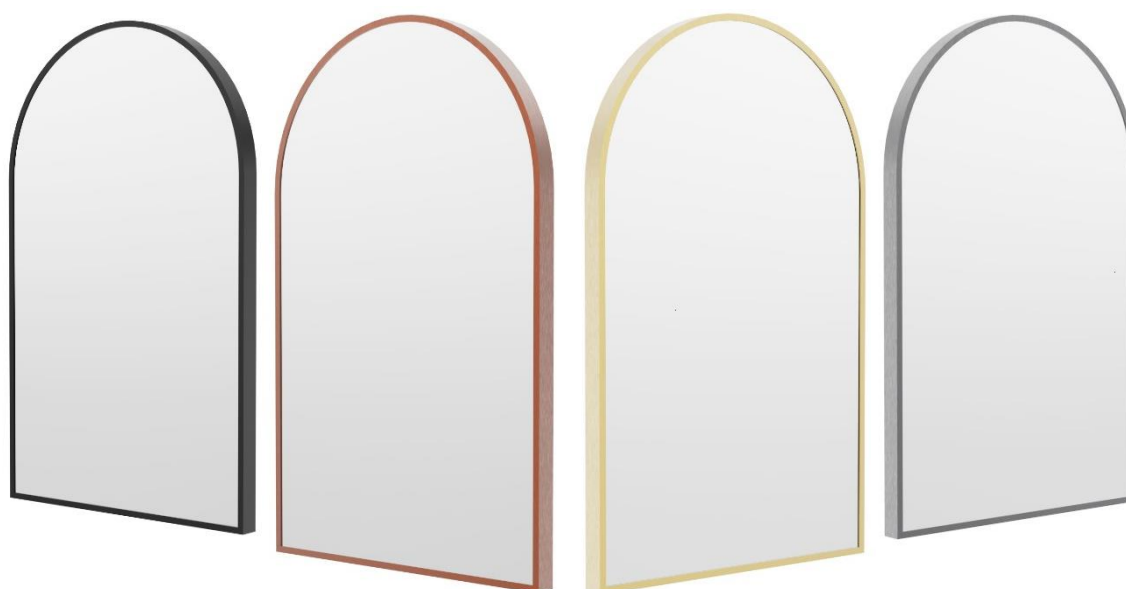

Thank you for choosing Better Bathrooms.
Please read this manual before installing your product
and keep for future reference.

better 
bathrooms

Arched Backlit Heated Bathroom Mirror with Lights 500x800mm Empire - Black / Brass / Bronze / Gun Metal



EMPIREMB500 EMPIREB500
EMPIREBB500 EMPIREGM500

- INFRARED SENSOR CONTROL
- DEMISTER
- SINGLE PERSON ASSEMBLY

CONGRATULATIONS ON YOUR PURCHASE

Our aim at Better Bathrooms is to bring you extraordinary bathroom products for less.

If you're after a modern, traditional, or totally unique bathroom style, we have the fittings and fixtures to bring your ideas to life so you can fall in love with your space every day.

We hope your new product goes above and beyond your expectations. However, should any problems occur, please:

- Log in to your account and contact our customer services team via your self-service portal – betterbathrooms.com/CustomerAccount/Login
- Contact us via betterbathrooms.com/contact/contact-us

CONTENTS

SAFETY	3
BATHROOM ZONES	4
PARTS SUPPLIED	5
TOOLS REQUIRED	5
DIMENSIONS	6
INSTALLATION	7
OPERATION	8
CLEANING AND MAINTENANCE	9
TECHNICAL SPECIFICATIONS	9

SAFETY

- This cabinet should be installed by a qualified electrician.
- This fitting is only suitable for connection to a 220- 240V~ earthed supply in accordance with current IEE wiring regulations and should be installed in accordance with local Building Regulations.
- This is for domestic, indoor use only.
- The fitting should be connected to a dedicated lighting circuit, which must be protected by a 5-amp fuse (or a 6-amp miniature circuit breaker).
- The electrical connection must be an adequate distance from the rear of the cabinet to prevent the risk of shorting with the cabinet's casing.
- Before installing the fitting, ensure the mains supply is switched off and that the appropriate fuse is removed (or the appropriate circuit breaker is switched off) before commencing installation. Ensure that measures are taken to prevent the supply from being inadvertently reconnected.
- If there is a "Minimum Distance" Label, please do not allow Flammable Materials to rest within that distance from the unit.
- This product may contain delicate parts – be careful during handling and maintenance to avoid breakage.
- Any modification to the fitting will invalidate the warranty and may render the product unsafe.
- A defective appliance may cause an electric shock. Never switch on a defective or damaged appliance. Disconnect the appliance from the mains before seeking assistance.
- This product is IP44 rated, and no part of the installation is allowed to be within bathroom Zones 0 or 1. Installation is permitted within Zone 2.
- This product must be earthed. Before commencing installation, ensure that there are no pipes or wires located behind the wall that may be damaged during drilling.
- Ensure that the hanging location has been decided upon and marked clearly to avoid unwanted damage to the wall due to incorrect positioning.
- Inspect the cabinet to ensure there are no signs of damage prior to installation.
- Take care of unpacking, and do not use a sharp blade to open it, as this may damage the mirror and void your warranty.
- Installation must only be carried out by a qualified professional or electrician.
- Once installed, silicone can be applied between the cabinet and the wall around the unit. Don't seal the bottom of the cabinet, as this may allow water to accumulate behind it.
- If the external flexible cable or cord of this luminaire is damaged, it shall be exclusively replaced by the manufacturer, its service agent or a similarly qualified person in order to avoid a hazard.
- To reduce the risk of strangulation the flexible wiring connected to this luminaire shall be effectively fixed to the wall if the wiring is within arm's reach.

- The light source of this luminaire is not replaceable; when the light source reaches its end of life, the whole luminaire shall be replaced.

BATHROOM ZONES

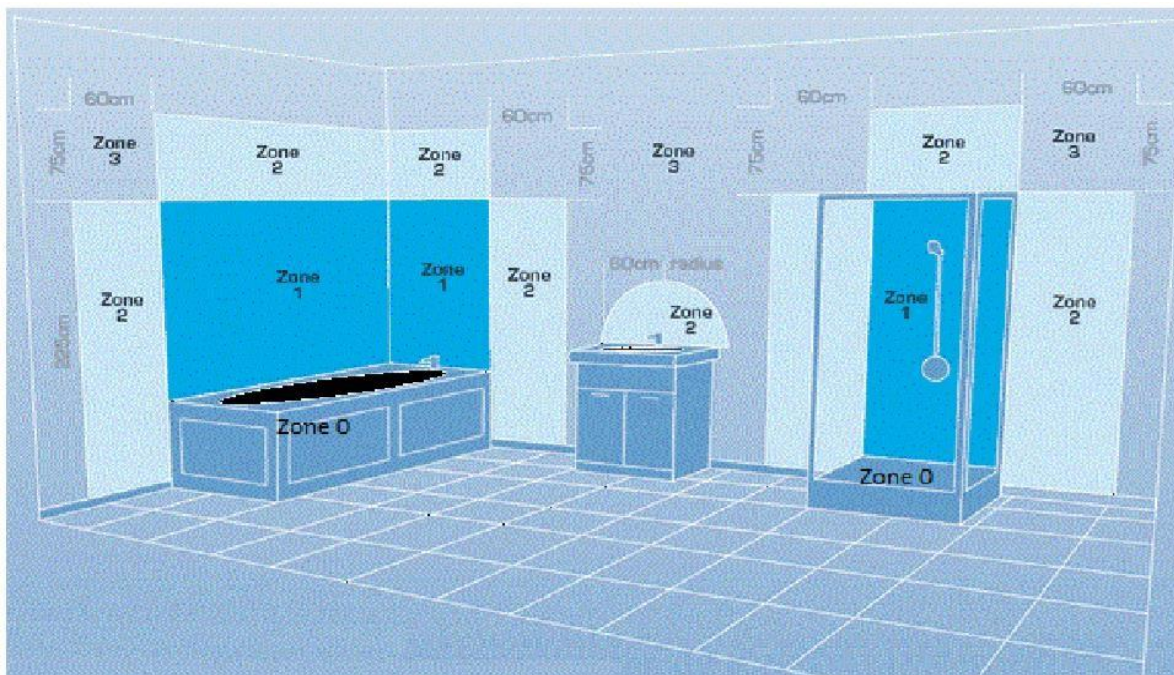

Zone 0:	The interior of the bathtub or shower basin.
Zone 1:	The area around the bathtub or shower basin up to a height of 2.25m above the floor.
Zone 2:	The area stretching to 0.6m outside the bath or shower and above the bath or shower if over 2.25m.

PARTS SUPPLIED

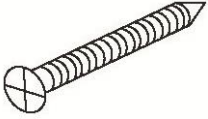
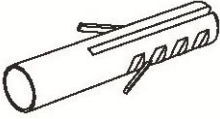
	
Screw M4 (x2)	Wall Plugs (x2)

PLEASE NOTE: It is the installers responsibility to ensure that the fittings are suitable for the type of wall. The parts provided are only suitable for masonry walls. Alternative fittings may be required (Not Supplied). If unsure, professional advice should be sought.

TOOLS REQUIRED (not supplied)

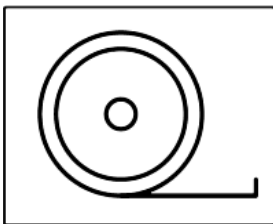

TAPE MEASURE

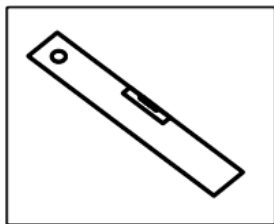

SPIRIT LEVEL

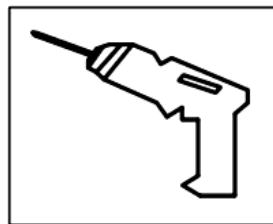

ELECTRIC DRILL

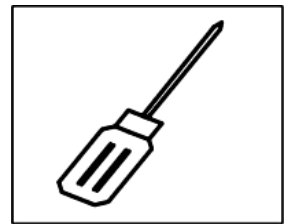

SCREWDRIVER

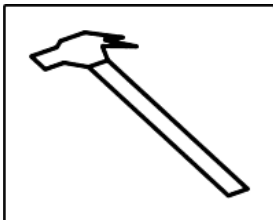

HAMMER

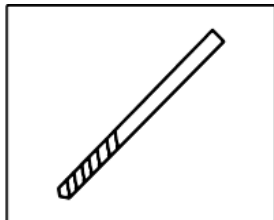

8mm DRILL BIT

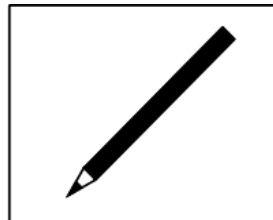

PENCIL

DIMENSIONS

NOTE: All diagrams are for illustrational purposes. All dimensions are in mm.

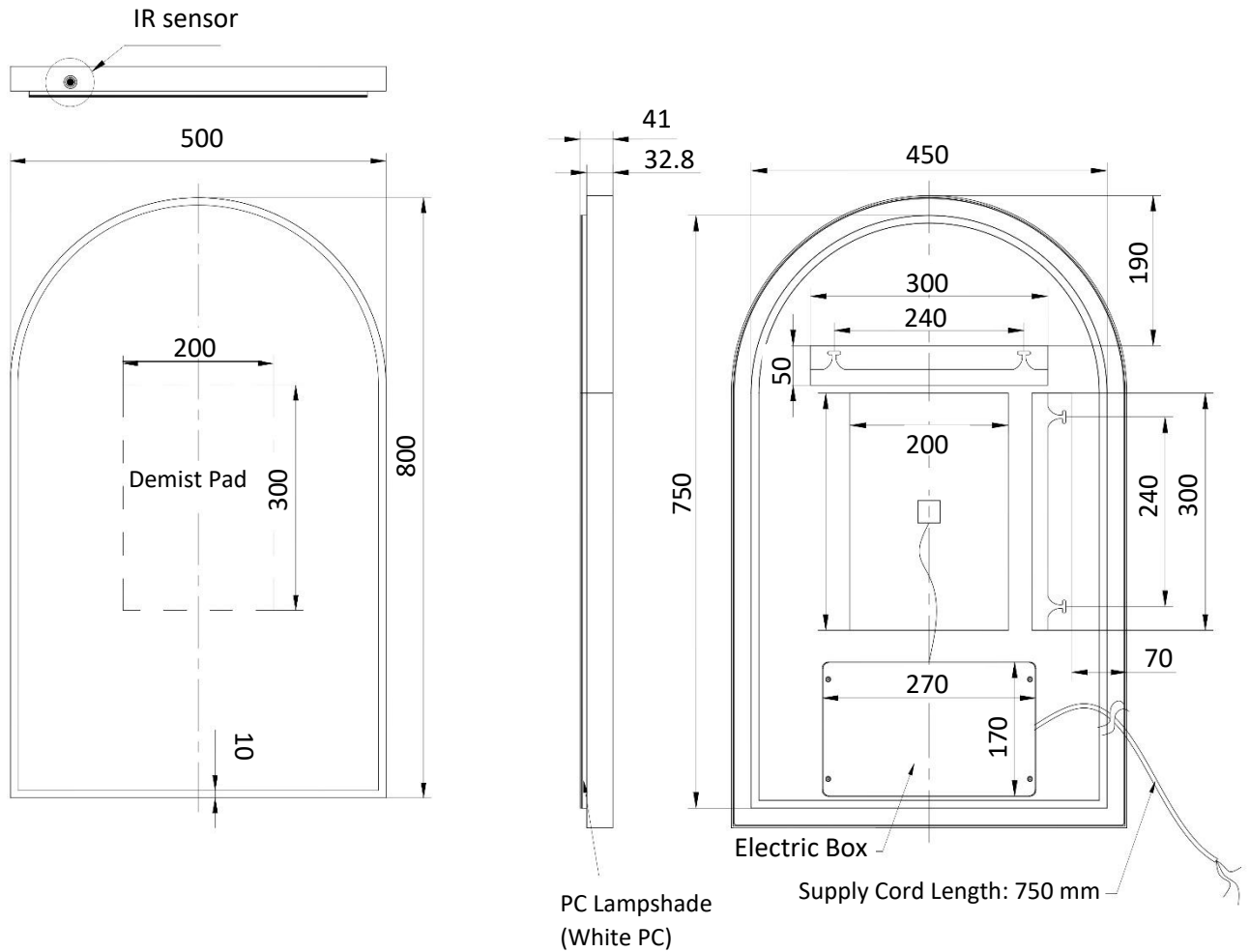

Dimensions Tolerance

Dimension Size	Tolerance Value
Up to 120 mm (4.72 in)	±1.27 mm (±0.05 in)
Over 120 mm (4.72 in)	±2.54 mm (±0.1 in)
Angles	±1°

IMPORTANT: Ensure the sensor is installed 150 mm away from any surface.

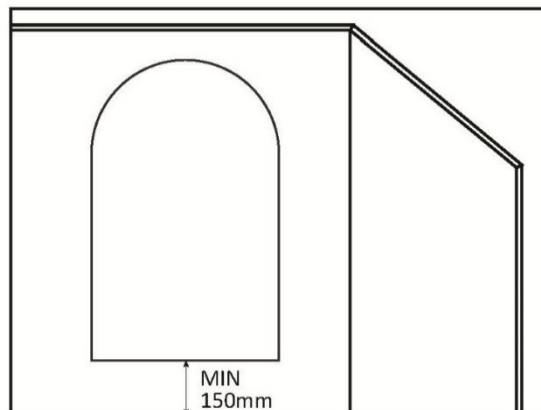

INSTALLATION

- **IMPORTANT:** Before commencing installation, ensure that there are no pipes or wires located behind the wall that you will be drilling into.
- **IMPORTANT:** The power must be disconnected when installing and performing any maintenance. The product dimensions are on page 6; alternatively, you can use the holes on the back of the mirror as a guide.
- Ensure that the hanging location has been decided upon and marked clearly to avoid unwanted damage to the wall due to incorrect positioning.
- Check that the mirror is not damaged prior to installation.
- Take care of unpacking, and do not use a sharp blade to open it, as this may damage the mirror and void your warranty.

At the back of the mirror, there are four hanging slots that allow it to be securely mounted either vertically or horizontally. To hang the mirror, two holes are required in the wall.

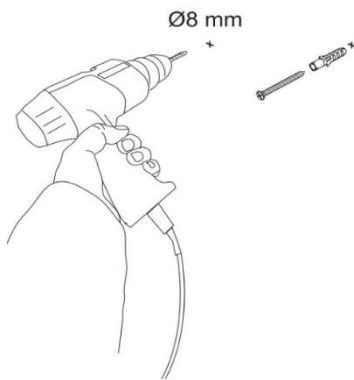

Step 1

Mark and drill the two holes for mounting. Then insert the wall plugs and screws.

Step 2

Connect the mirror to the power by hardwiring. All electrical connections must be carried out by a qualified electrician.

All wiring connections must be securely made in accordance with the wiring diagram. All electrical equipment within a bathroom or shower room must be connected to a residual current device (RCD) as per the Building Regulations.

Wiring Colour Coding:

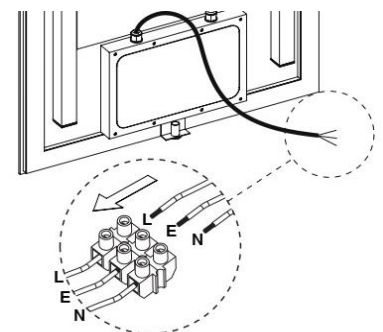
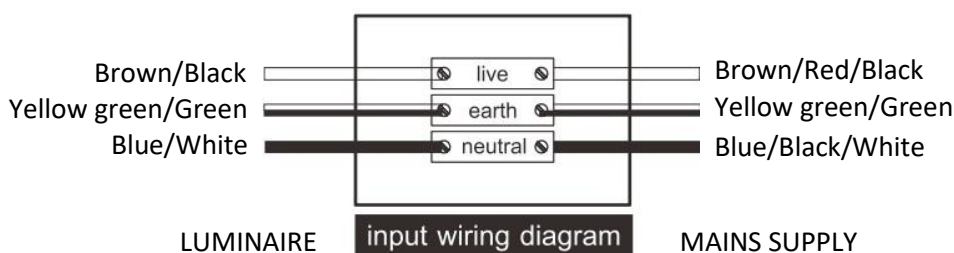

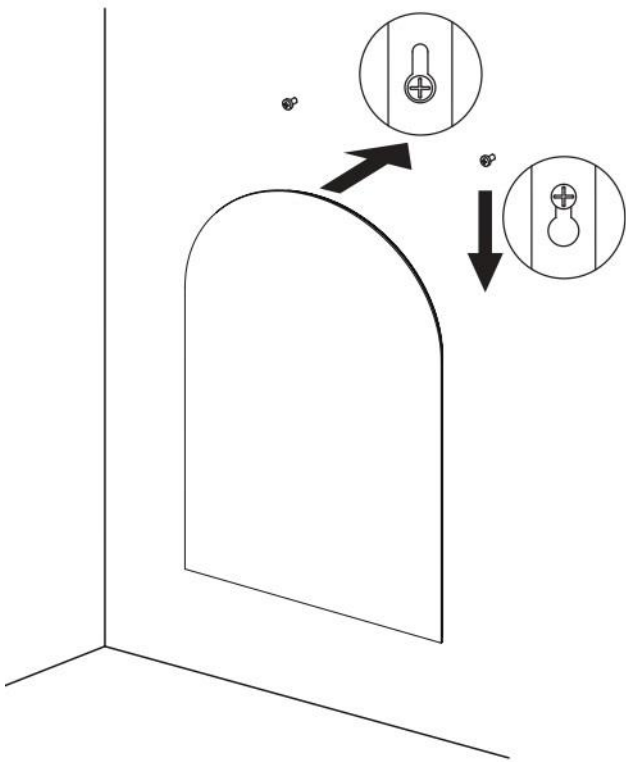

Step 3

Secure the mirror by aligning the screw heads with the slots on the back of the mirror. Once aligned, carefully lower the mirror so that it locks into position. Ensure the unit is firmly seated and stable before use.

OPERATION

Your mirror features an infrared (IR) sensor located on the right-hand side for easy touch-free control.

Turning On/Off: Move your hand across the sensor from a distance of approximately 5 cm to switch the light and demisting pad on. Move your hand across the sensor again to turn them off.

Adjusting Brightness: When the light is on, hold your hand in front of the sensor to adjust the brightness level.

Changing Colour Temperature: Wave your hand past the sensor to switch between warm (3000K), neutral (4000K), and cool (6500K).

CLEANING AND MAINTENANCE

Never use products containing bleach or abrasive cleaners, as this will harm the product's appearance and lifespan.

Use a clean microfibre cloth to clean the mirror.

TECHNICAL SPECIFICATION

Model	EMPIREBB500/EMPIREMB500 EMPIREGM500/ EMPIREB500
WxHxD (mm)	500 x 800 x 41
Net Weight (Kg)	5.6
Power Cord length (cm)	75
Rated Power (W)	29
IP Rating	IP44
Input	220-240V~ 50 Hz

This product contains a light source of energy efficiency class F and must only be replaced by the manufacturer, its service agent or a similarly qualified person.

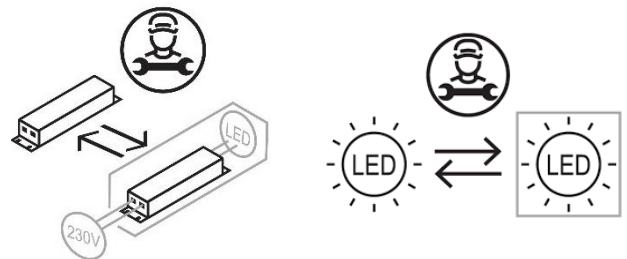

DISPOSAL

Recycling facilities are now available for all customers at which you can deposit your old electrical products. Customers will be able to take any old electrical equipment to participating sites run by their local councils.

Please remember that this equipment will be further handled during the recycling process, so please be considerate when depositing your equipment. Please get in touch with the local council for details of your local household waste recycling centres.

At the time of printing the product contains no substances listed within Annex XIV of the Reach Regulations (EC) 1907/2006. In accordance with Article 59 of the same regulation, the following substances are contained within the product at permitted levels: Cadmium.

As a responsible manufacturer, we monitor the regulations to ensure continued compliance. Further information can be provided upon request.



For more information

- visit betterbathrooms.com
- email support@betterbathrooms.co.uk
- call 0330 390 3062
- write to Trident Business Park, Neptune Way, Huddersfield, HD2 1UA

**better
bathrooms**

Part of the BuyItDirect Group